

Thank you for purchasing our product
Please read this user Manual before
using the product. Change without Notice

RayView

7" Q TFT LCD MONITOR (LED Backlight) USER MANUAL

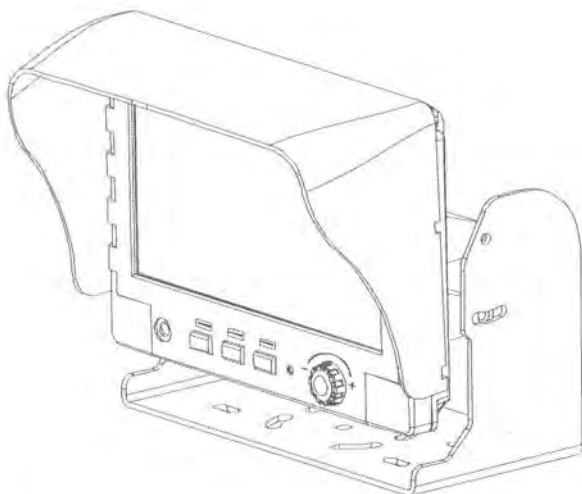

RayView

Holtz Industries, INC.
200 South Terrace Court
Newark Ohio 43055
Tel: 1-800-535-0104

e-4 FC

SAFETY PRECAUTIONS

Federal Communications Commission (FCC) Statement

This Equipment has been tested and found to comply with the limits for a Class B digital device, pursuant to Part 15 of the FCC rules. These limits are designed to provide reasonable protection against harmful interference in a residential installation. This equipment generates, uses and can radiate radio frequency

energy and, if not installed and used in accordance with the instructions, may cause harmful interference to radio communications. However, there is no guarantee that interference will not occur in a particular installation. If this equipment does cause harmful interference to radio or television reception, which can be determined by turning the equipment off and on, the user is encouraged to try to correct the interference by one or more of the following measures:

- Reorient or relocate the receiving antenna.
 - Increase the separation between the equipment and receiver.
 - Connect the equipment into an outlet on a circuit different from that to which the receiver is connected.
 - Consult the dealer or an experienced radio / TV technician for help.
- You are cautioned that changes or modifications not expressly approved by the party responsible for compliance could void your authority to operate the equipment.

This device complies with Part 15 of the FCC Rules. Operation is subject to the following two conditions:

- (1) This device may not cause harmful interference and,
- (2) This device must accept any interference received, including interference that may cause undesired operation

TABLE OF CONTENT

Safety Precaution.....	2
Table of Content.....	3
Features.....	4
1. Package Contents.....	5
2. TFT Installation.....	6
3. Signal Cable Description.....	7
4. Control Cable Description.....	9
5. Front Panel Control.....	10
Main OSD Menu.....	11
Screen Menu.....	12
Display Menu.....	14
Camera Menu.....	15
Factory Setting Menu.....	17
6. Vehicle Installation	18
7. Specification.....	19
8. Attachment.....	20

FEATURE

- Advanced OSD Menu for easy use
- Support up to 4 CCD Camera inputs (Mini din connector)
- Extra RCA input for multimedia while parking (VCD, DVD, Game device)
- Provide 2 Video / 1 Audio Signal Output (Live Out)
- Support Single / Dual / Triple / Quad Screen (Cam Out)
- Signal Trigger for Side / Rear View
- Auto Day & Night Control via Photo Diode Sensor
- Auto Detection for NTSC / PAL System
- OSD Control for Individual Normal / Mirror Camera Image for every camera
- Auto power on when users are making left turn or right turn even reverse
- Able to select CAM A / B/C / R's monitoring screen
- Supported 9.6V~32V Car power system working
- Professional Metal Case with Anti Shocking Design

1. Package Contents

Item	Qty.
1. 7" LCD Monitor	1
2. Sun-Hood	1
3. Mounting Bracket	1
4. Accessories	1
5. Control Cable	1
6. User Manual	1

2. TFT Installation



Step 1

Check the package and make sure all parts are included.



Step 2

Clip the sun-hood on to the monitor.



Step 3

Make sure it is installed properly.

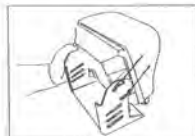

Step 4

Install the monitor on to the bracket.



Step 5

Adjust the monitor to an appropriate / comfortable viewing angle before tightening the screws.

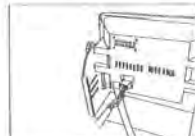

Step 6

Connect the control cable included to the power socket which located at rear side of monitor.



Step 7

Monitor installation is now completed. Each control cable wire is attached with a sticker to indicate its signal function. Referred to the identification sticker for further installation.

3. Signal Cable Description

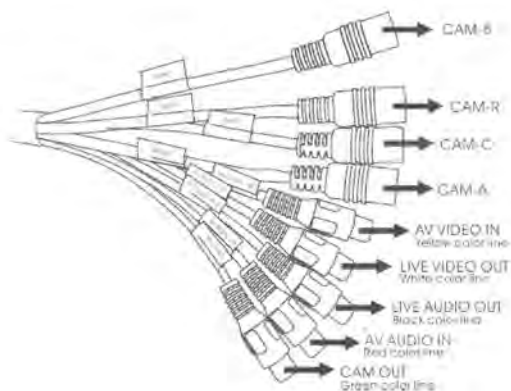

1. CAM R (Mini din)
For 1st camera connection
2. CAM A (Mini din)
For 2nd camera connection
3. CAM B (Mini din)
For 3rd camera connection
4. CAM C (Mini din)
For 4th camera connection
5. LIVE VIDEO OUT (White Color RCA Jack)
On screen video loop out (for recording, second monitor or other device)
6. LIVE AUDIO OUT (Black Color RCA Jack)
On screen audio loop out (for recording, second monitor or other device)
7. AV VIDEO IN (Yellow Color RCA Jack)
Connection for any Video signal (DVD, VCD, Game)
8. AV AUDIO IN (Red Color RCA Jack)
Connection for any Audio signal (such as DVD, VCD, Game)
9. CAM OUT (Green Color RCA Jack)
Video loop out (for recording, second monitor or other device)

Mini Din Pin Assignment

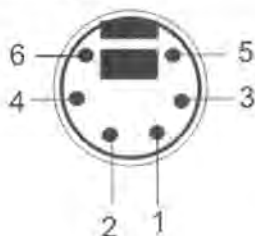

* Type 1 (Standard):

- 1. ---- 4. GND
- 2. --- 5. +12V
- 3. Audio 6. Video

*Type 2 (Optional):

- 1. GND 4. +12V
- 2. --- 5. ---
- 3. Video 6. Audio

Function of the Audio





Cam A	Audio from Cam A
Cam B	Audio from Cam B
Cam C	Audio from Cam C
Cam R	Audio from Cam R
Cam A + Cam B	Audio from Cam A
Cam C+ Cam R	Audio from Cam R
Cam A+ Cam R	Audio from Cam R
Cam R+ Cam B	Audio from Cam R
Cam A + Cam C	Audio from Cam A
Cam C+ Cam B	Audio from Cam C
Cam R / Cam AB	Audio from Cam R
Quad	Audio from Cam R
AV	Audio from AV

- ※ Cam Out: Composite video loop out signal to recorder, monitor or other device.
- ※ Live Video/Audio Out: On screen video/audio signal loop out to recorder, monitor or other device.

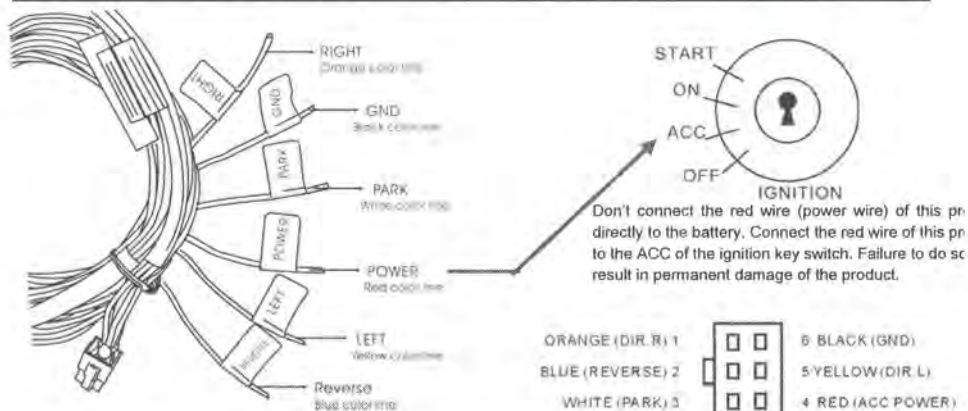
- 2 -

4. Control cable Description



WIRE COLOR	FUNCTION	REMARK	ON SCREEN VIEW
RED	ACC POWER		
BLACK	GND		
WHITE	Parking Control	Active GND	
BLUE	Reverse Control	Active Power Level Connect to Reverse Light	
ORANGE	Right Turn Control	Active Power Level Connect to Direction Light (R)	
YELLOW	Left Turn Control	Active Power Level Connect to Direction Light (L)	

1. The control cable sequence: Reverse > Right / Left > Park (AV)
2. With car power is on, the monitor power is off, when making a reverse / right / left turn, the monitor will display default screen.
3. *When pull the hand break, user need to press SOURCE button again to display AV IN picture

5. Front Panel Control



POWER Press the power button to activate the monitor or to keep the monitor under stand by mode (In Red Led).

SOURCE With power on, press this button to select image sequence as below~
CAM A→CAM B→CAM C→CAM R →CAM A+B →CAM C+R →
CAM A+R→CAM R+B→CAM A+C→CAM C+B →CAM R/AB →
CAM R+AB→CAM A.....

With pull hand break, press this button to select image sequence as below~
AV→CAM A+B→CAM C+R→CAM A+R→CAM R+B→CAM A+C→
CAM C+B→CAM R/AB→CAM R+AB→CAM A→CAM B→CAM C→
CAM R →AV.....

JUMP Press this button to display defined camera input, user can select
QUAD→SEQ→CAM A+B→CAM C+R→CAM A+R→CAM R+B→
CAM A+C→CAM C+B→CAM R/AB →CAM R+AB →CAM A →CAM B
CAM C→CAM R via OSD as default value.

MENU This encoder switch provides the following function:

1. Activate OSD menu: Press the Menu switch to activate the OSD menu.
After the OSD menu is activated, in case users does not proceed for further set up, the OSD menu will then automatically turn off within 20 seconds.
2. Enter Function: Press the encoder switch to act as "Enter" function under the OSD menu.
3. Volume Value: Exit the OSD menu, user can turn this switch left or right to adjust the volume value.

OSD Menu

1. Press the MENU button to enter to the OSD Menu
2. Turn the MENU button left or right to select the setting you wish to proceed. The color of the content will turns YELLOW to identify your selection. Turn the MENU button left or right to adjust your setting value.
3. Press the MENU button once back to submenu and then press menu button again in order to return to OSD menu.

Enter to Main menu:





SCREEN Menu

This menu set up contains different setting for the TFT LCD.

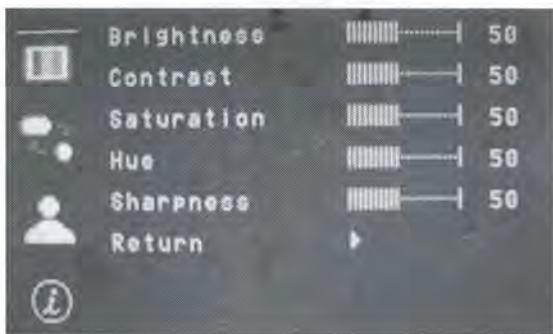

Brightness

Provide adjustment for shade and brightness level of TFT display. Setting value from 0 ~ 100. Default value is 50.

Contrast

Provide adjustment for the light and dark level of the TFT display. Setting value from 0 ~ 100. Default value is 50.

Saturation

Provide adjustment for the light intensity level of TFT display. Setting value from 0 ~ 100. Default value is 50.

Hue

Provide adjustment for the lightness and colorfulness level of TFT display. Setting value from 0 ~ 100. Default value is 50.
(Only in NTSC system is available.)

Sharpness

Provide adjustment for the edge contrast (acutance) level of TFT display. Setting value from 0 ~ 100. Default value is 50.

Return

Return to OSD menu selection screen.



DISPLAY Menu

This menu set up contains the on screen identification and distance gauge.

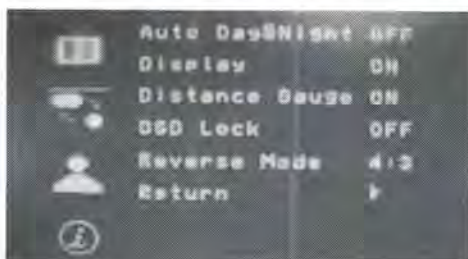

Auto Day&Night

Select "ON" to activate the auto day & night function or "OFF" to deactivate it. Default value is OFF.

Display

Select "ON" to show the source of video input title on screen or "OFF" to keep it invisible. Default value is ON.

Distance Gauge

Set the distance gauge "ON" to show the distance gauge on screen while reserving or "OFF" to deactivate. Default value is ON.
(This "DISTANCE GAUGE" is for user's reference only)

OSD Lock

This function provides protection when an unauthorized person tries to access the OSD settings. JUMP and Source key press simultaneously for over 5 seconds to unlock. Default value is OFF.

※Users must turn on LCD in order to run unlock process. All function buttons are still working during OSD Menu lock up period.

REVERSE MODE

When reversing select LCD profile ratio 4:3 the display show in size 4:3(default), select LCD profile ratio 16:9 the display show in size 16:9

Return

Return to OSD menu selection screen.



CAMERA Menu

This menu set up contains the on Camera and Jump setting.

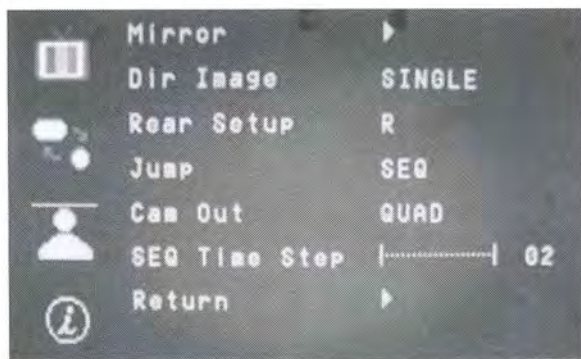

Mirror

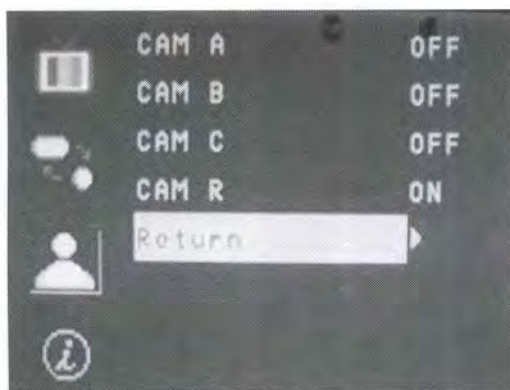

Select "ON" to activate the mirror function for different cameras or "OFF" for a normal image. Default values are following below setting.

CAM A	"OFF"
CAM B	"OFF"
CAM C	"OFF"
CAM R	"ON"

Dir Image

The screen image setting of this panel during left / right turn:

TRIPLE: When you are making a right turn or left turn, the screen of panel will display triple images for left hand side, right hand side and rear view when you are making a right turn or left turn.

DUAL: With proper wiring, the screen will display dual image for both rear and right hand side view when making a right turn. While left turning, the screen will show dual image for both rear and left hand side view.

SINGLE: Screen of touch panel shows only single picture on direction turn. The screen will show only left side view on left turn and only right side view on right turn.

Default value is SINGLE.

Rear Setup

The screen image setting of this panel during reverse gear:

R: Screen will display single image for Cam R only.

R+A: Screen will display dual image for both Cam R and Cam A.

R+B: Screen will display dual image for both Cam R and Cam B.

R/AB Screen will display triple image from Cam R · Cam A · Cam B.

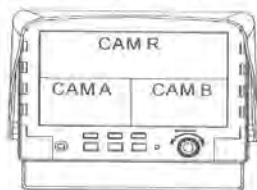

--- **R+AB** Screen will display triple image from Cam R · Cam A · Cam B.



Default value is R.

Jump

By pressing this button, the driver will be able to obtain the image selected under this setting.

QUAD	Obtain image from all camera input in quad picture while pressing the JUMP button and press again to return the default screen.
SEQ.	Corresponding with "SEQ. Timer Step" setting to jump channel by time sequence.
CAMA	Obtain image from camera A while pressing the JUMP button and press again to return the default screen.
CAM B	Obtain image from camera B while pressing the JUMP button and press again to return the default screen.
CAM C	Obtain image from camera C while pressing the JUMP button and press again to return the default screen.
CAM R	Obtain image from camera R while pressing the JUMP button and press again to return the default screen.
CAMA+B	Obtain image from camera A+B in dual picture while pressing the JUMP button and press again to return the default screen.
CAM C+R	Obtain image from camera C+R in dual picture while pressing the JUMP button and press again to return the default screen.
CAMA+R	Obtain image from camera A+R in dual picture while pressing the JUMP button and press again to return the default screen.
CAM R+B	Obtain image from camera R+B in dual picture while pressing the JUMP button and press again to return the default screen.
CAM A+C	Obtain image from camera A+C in dual picture while pressing the JUMP button and press again to return the default screen.
CAM C+B	Obtain image from camera C+B in dual picture while pressing the JUMP button and press again to return the default screen.
CAM R/AB	Obtain image from camera R+A+B in triple picture while pressing the JUMP button and press again to return the default screen.
CAM R+AB	Obtain image from camera R+A+B in triple picture while pressing the JUMP button and press again to return the default screen.

Default value is QUAD.

Cam Out

Composite video loop out to recorder, monitor or other device.

QUAD	Recording or viewing from the output device in quad mode
CAM A	Recording or viewing from the output device for CAM A image
CAM B	Recording or viewing from the output device for CAM B image
CAM C	Recording or viewing from the output device for CAM C image
CAM R	Recording or viewing from the output device for CAM R image

Default value is QUAD.

SEQ Time Step

Select Cam A/B/C/R switching time setting value from 02~100

Default value is "02"

RETURN

Return to OSD menu selection screen.



Information

This menu set up contains Recall & Exit function.

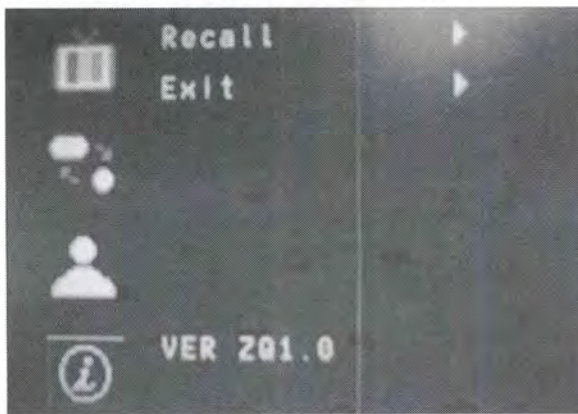

Recall

Recall factory default.

Exit

Exit OSD menu.

Notice : Firmware version has shown on last column.

6. Vehicle Installation

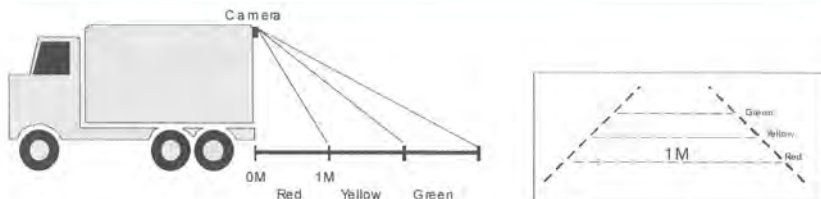

(This "DISTANCE GAUGE" is for user's reference only)

- Install Camera R (for rear view).
- Use a measuring tool to mark out the distance behind the vehicle.
- Adjust the viewing angle of the camera so that the distance gauge shown from the TFT match to the distance marks behind the vehicle.

Switch to Rear view with source button, the screen always display on 16:9
While rear viewing, the screen always display on 4:3 to correct size percentage

SOURCE button:

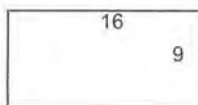

Rear viewing:

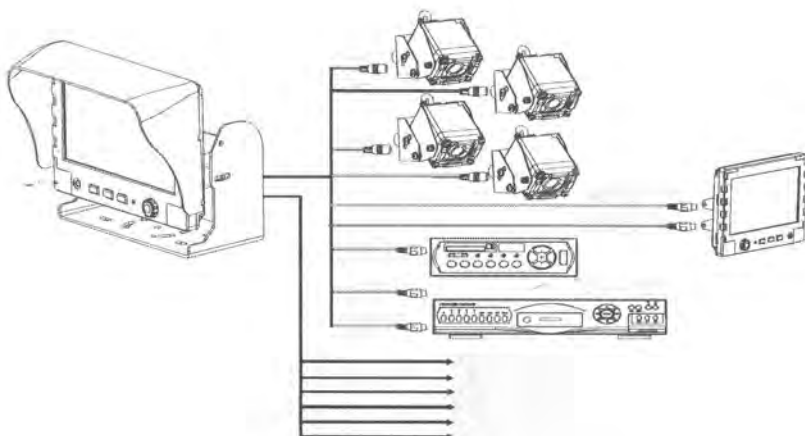
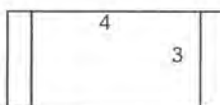

7. Specification

Screen size	7 Inch (diagonal)
Active area	154.08(H) x 86.58(V)
Pixel configuration	0.107 x 0.370
Resolution	1440(W) x 234 (H)
Viewing angle	UP:40° / Down:60° / Left: 60° / Right:60°
Power source:	DC9.6V ~DC32V
Contrast ratio	300:1 ※
Brightness	450 cd/m ² ※
AV Video In	
Connector	RCA
Input Signal	1Vpp
Impedance	75 Ohms
Camera MINI DIN In	
Connector	6 PIN MINI DIN (Standard)
Input video signal level	1Vpp
Impedance	75 Ohms
Input audio signal level	1Vpp
Power output for camera	DC12V (350mA Max)
AV Audio In	
Connector	RCA
Input video signal level	1Vpp
Impedance	1K Ohms
Live Video Out	
Connector	RCA
Input signal level	1Vpp
Impedance	75 Ohms
CAM OUT	
Connector	RCA
Input signal level	1Vpp
Impedance	75 Ohms
Live Audio Out	
Connector	RCA
Input signal level	1Vpp
Impedance	1K Ohms
Dimension	
W x H x D :	192 x140.5 x 51.8mm
Weight	N.W./G.W.: 2kg/ 2.28kg
Environmental:	
Operation temperature	-10℃ ~70℃
Storage temperature	-30℃ ~80℃
Humidity	20%-80%

※The brightness and contrast ratio specifications are from panel specification.
Design and Specifications are subject to change without notice.

VER ZQ1.0

8. ATTACHMENT

Attachment 1: Dimension Chart

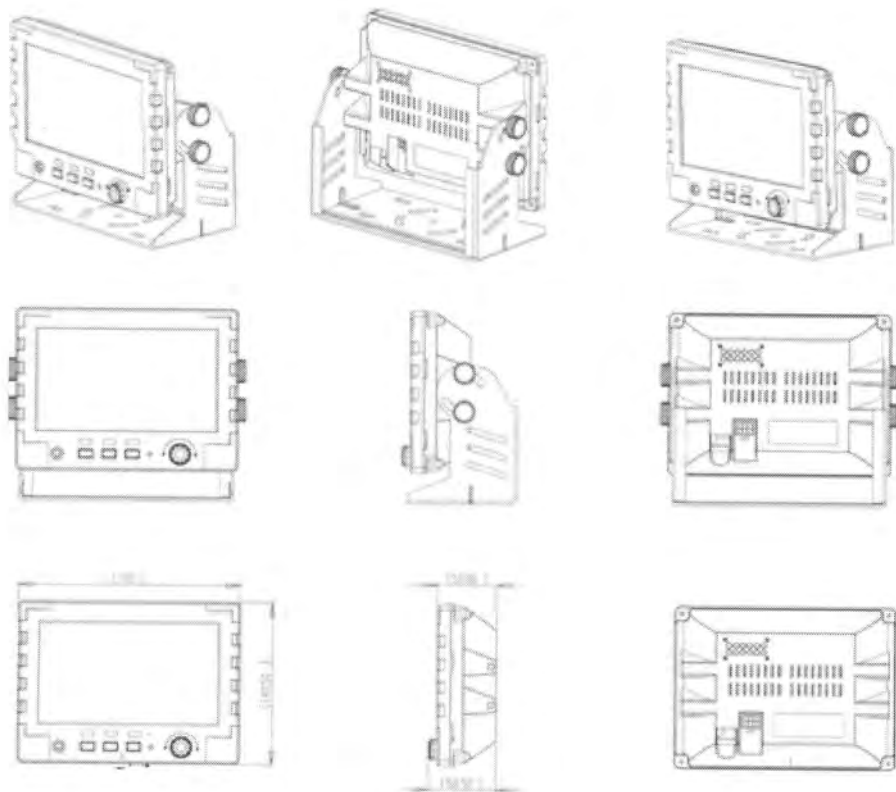

Attachment 2: Installation Chart

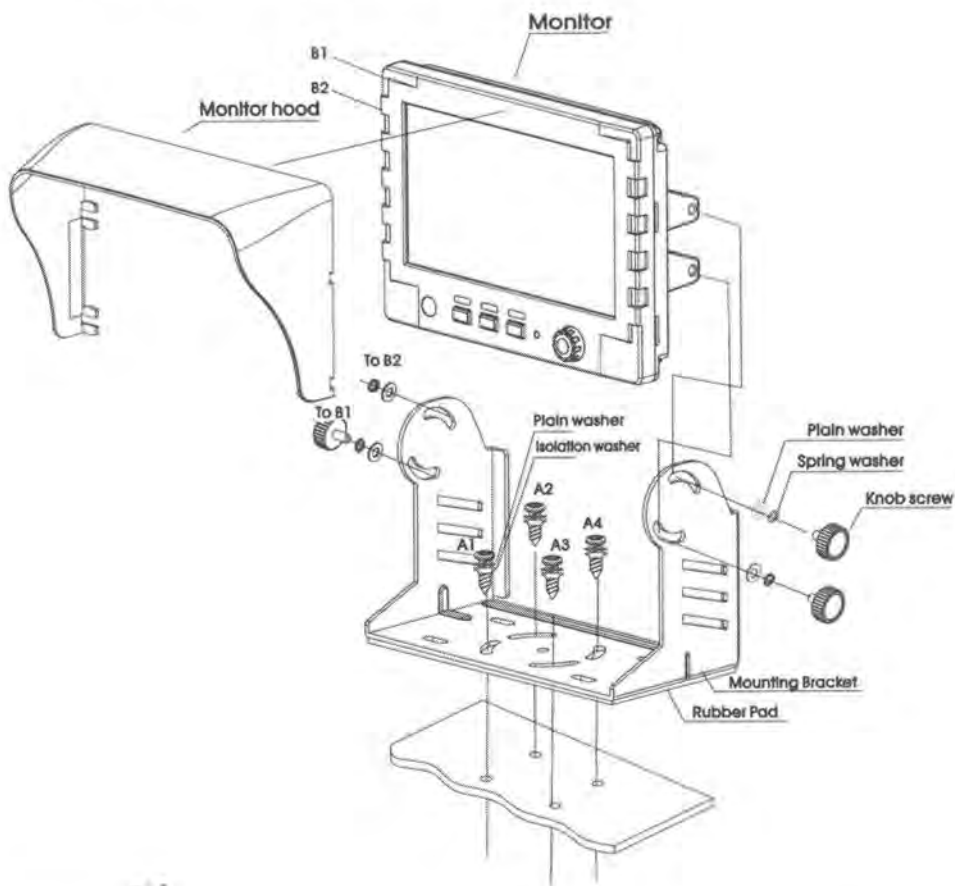

Notice:

Please proceed with suggested installation instruction according to above picture to avoid any malfunction of the product.